

Varenummer: 04085774  
 Beskrivelse: Stabilus Lift-O-Mat Gasfjeder 085774 1900N  
 14 400 1900 Øje/Øje.

## Mål

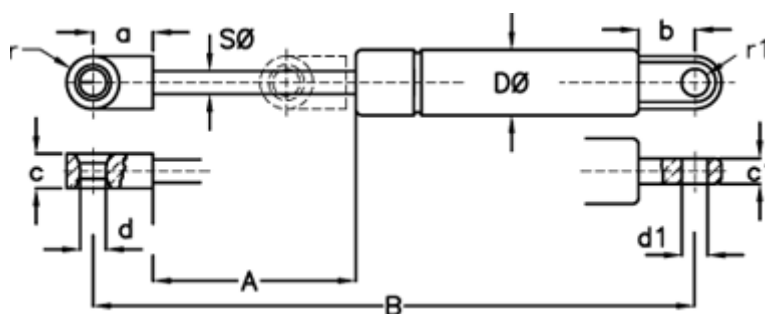

A	= 400	d $\varnothing$	= 10,1 +0,1
a	= 24	D $\varnothing$	= 28
B	= 900 +/-2	Materiale	= Metal
b	= 15	Note	= -
Befæstigelse	= Øje/Øje	Note	= -
c	= 18	r	= 9
c1	= 8	r1	= 8
d1 $\varnothing$	= 10,1 +0,1 -0,2	S $\varnothing$	= 14